

1 General Description

The Millswood Engineering 250W Power Management Unit provides up to 250 Watts of on-board electrical power generation for small to medium-sized UAVs. A variant manufactured for Currawong Engineering is available with an optional engine starter.

The 250W PMU simplifies UAV power distribution by providing multiple power outputs, which are individually programmable for voltage as well as being battery-backed. Dual (redundant) battery support is also included as standard.



Figure 1 – 250W PMU

The PMU connects to a suitable brushless DC electric motor, which is in turn driven by the aircraft's primary power plant, usually an internal combustion engine.

2 Features

- Buck-boost converter allows electrical power generation over 4:1 RPM range.
- Multiple independent, individually user-programmable power outputs:
 - Avionics: 12 – 21 VDC
 - Payload: 12 – 21 VDC
 - Servo: 5 – 12 VDC
- Outputs are battery-backed and switchable (on/off) via hardware signal or remotely via command.
- Dual (redundant) battery support. The PMU includes two independent and identical battery chargers. Supported battery types include:
 - LiPo: 5S, 6S
 - LiS: 8S, 9S, 10S
 - LiFe: 6S, 7S
- Industry-standard 28 VDC output (available during power generation and when the PMU is connected to umbilical power).
- RS232 and CAN control and monitoring interfaces provide extensive monitoring and reporting of voltages, currents, battery charge status and temperatures.
- Optional engine starter may be activated locally via a momentary push-button switch, or remotely via command to facilitate in-flight engine restarting (Currawong Engineering variant).
- Weight: 290 grams (10.2 ounces).
- Dimensions: 124.4 x 85.0 x 32.5mm.

This page intentionally left blank.

3 Contents

1	General Description	1
2	Features	1
3	Contents	3
4	Operation	5
4.1	Internal architecture	5
4.2	Battery backup	6
4.3	Shutdown inputs	6
4.4	Temperature monitoring	6
4.4.1	Internal	6
4.4.2	External	6
4.5	Safe Operating Area	7
5	Communications	8
5.1	RS232 interface	8
5.2	CAN interface	8
6	Connectors.....	9
6.1	X1 – BLDC motor	10
6.1.1	Engine starting	10
6.2	X2 – Batteries.....	12
6.2.1	Choosing batteries	12
6.2.2	Additional considerations when choosing battery voltage.....	13
6.2.3	Battery chargers	13
6.2.4	Low battery voltage cut-out.....	13
6.2.5	Minimum battery voltage requirement	13
6.3	X3 – Avionics.....	15
6.4	X4 – Servo / Payload	16
7	Front Panel Arrangement	17
7.1	Connector pin locations.....	17
7.2	Visual indicator locations	17
8	Specifications	18
8.1	Absolute Maximum Ratings ^{Note 1}	18
8.2	Recommended Operating Conditions.....	18
8.3	Thermal Characteristics.....	18
8.4	Electrical Specifications (-40 to +85°C, typical values given for +25°C)	19
8.4.1	Power outputs	19
8.4.2	Quiescent characteristics.....	20
8.4.3	Communications interfaces.....	20
8.4.4	Digital and analog inputs.....	20
8.4.5	Monitoring.....	21
8.5	Typical Characteristics (+25°C).....	22
8.5.1	Quiescent battery current.....	22
8.5.2	Avionics output dropout voltage.....	22
8.5.3	Maximum payload and servo output voltages.....	23
8.6	Mechanical Characteristics.....	24
8.6.1	Mounting.....	25
9	Document version history	25
9.1	1.0 -> 1.1	25
9.1.1	Typical Performance Characteristics.....	25
9.1.2	Interfacing renamed to Operation	25
9.1.3	Connectors section moved to precede sub sections describing each connector ..	25
9.1.4	Front Panel Arrangement	26
9.1.5	Specifications	26
9.2	1.1 -> 1.2.....	26

9.2.1	Typical Performance Characteristics.....	26
9.3	1.2 -> 1.3	26
9.3.1	This section renamed to Document version history	26
9.3.2	Mechanical Characteristics.....	26
9.3.3	Appendix 2 – Thermal Management.....	26
9.3.4	Connectors.....	26
9.3.5	Document reformatted to suit printing and binding.....	26
9.4	1.3 -> 1.4	26
9.4.1	Safe Operating Area	26
9.4.2	CAN interface	26
9.5	1.4 -> 1.5	26
9.5.1	Direction input.....	26
9.5.2	Firmware version 1.16	26
10	Appendix 1 – Choosing a suitable BLDC motor	27
10.1	Types of BLDC motors	27
10.2	Calculating the optimal Kv.....	27
10.3	Pole count	27
10.4	Recommended BLDC motors.....	27
11	Appendix 2 – Thermal management	28
11.1	Recommendations.....	28

4 Operation

The 250W PMU takes power from 4 possible sources and creates 4 regulated output rails as shown in Table 1 and Table 2 below:

Power inputs	
BLDC motor	3-phase AC input
Umbilical	DC input
Battery A	Bi-directional
Battery B	Bi-directional

Table 1 – Power inputs

Power outputs	
28VDC bus	Bi-directional
Avionics	DC output
Servo	DC output
Payload	DC output

Table 2 – Power outputs

Two of the four power sources are batteries. The PMU draws power from the batteries when other power sources are not present, or charges them when other power sources are present.

The 28VDC bus is usually used as an output, but it can also be used as an input to improve redundancy if multiple PMUs are present (such as in twin-engined aircraft). The 28VDC bus is only maintained at 28V when electrical power generation (from the BLDC motor) is occurring, or umbilical power is present. When operating from battery power, the 28VDC bus assumes the highest battery voltage available.

The avionics, servo and payload outputs are all user-configurable for voltage, and the payload output can be shed automatically when the PMU is operating from battery power alone.

4.1 Internal architecture

The internal architecture of the PMU is shown in Figure 2 below. Only the main power pathways are shown. Diodes shown are not physical diodes; they are “ideal diodes” implemented with FET switches.

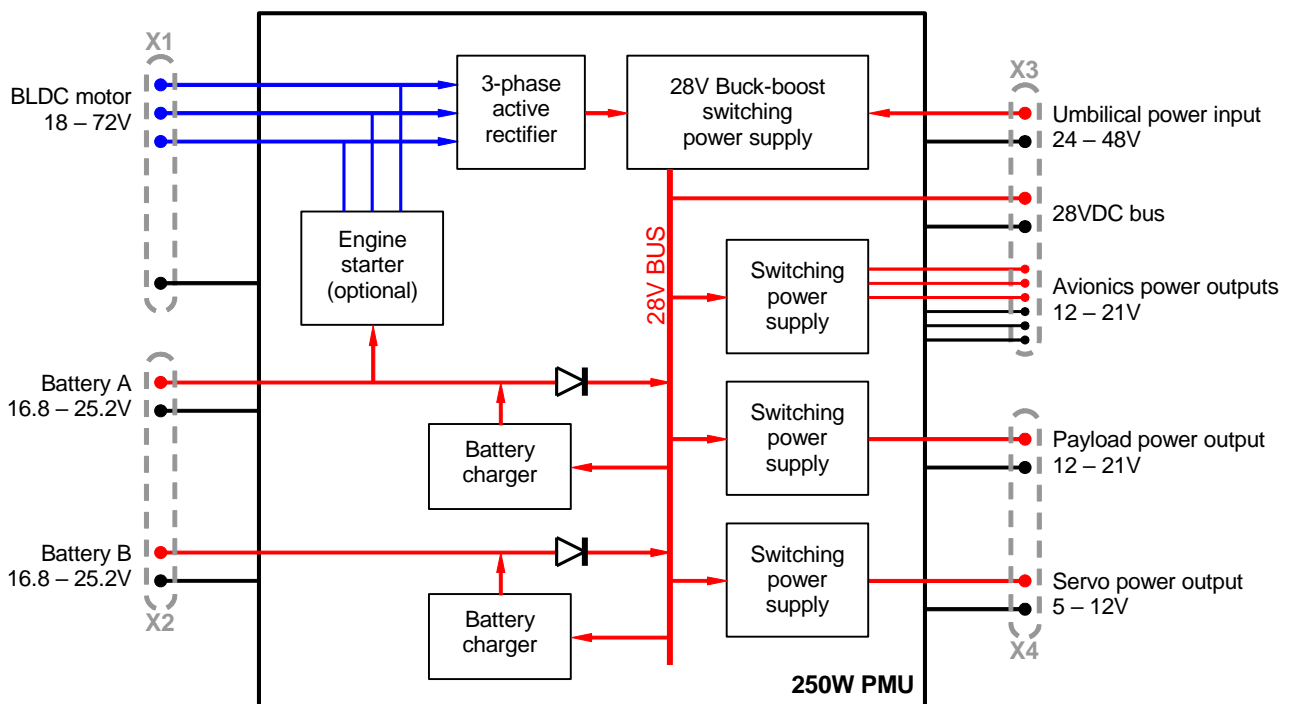

Figure 2 – PMU internal architecture

One of the main features of the PMU is that electrical power generation can occur over a very wide RPM range – up to 4:1 if the system is designed optimally. This is possible because the main 28V switching power supply (shown in the top right-hand corner of Figure 2 above) creates a regulated 28VDC bus regardless of whether the input voltage is less than or greater than 28V.

4.2 Battery backup

The Avionics, Servo and Payload outputs are all battery-backed. In other words, when electrical power generation and umbilical power are not present, outputs are maintained using battery power.

4.3 Shutdown inputs

The Avionics, Servo and Payload outputs each have a dedicated shutdown input pin. When a shutdown pin is pulled low (via a switch or open collector output), the respective output is turned off. These shutdown inputs are implemented in hardware and override software control of output state. The shutdown inputs may be connected together to form a master shutdown input if desired. The 28VDC bus and communications interfaces remain active regardless of the state of the shutdown inputs.

4.4 Temperature monitoring

4.4.1 Internal

The internal temperature of the PMU is sensed and reported, and there is a user-programmable upper temperature limit T_U . When T_U is exceeded, thermal shutdown occurs. Thermal shutdown means that electrical power generation and battery charging cease, but the avionics, servo and payload outputs are not affected as long as at least one battery is connected. During thermal shutdown, the 28VDC bus assumes the highest available battery voltage.

4.4.2 External

A number of external temperature sensors may be connected to the PMU, and the resulting values are all reported in the telemetry streams. Battery A, Battery B, the engine starter module and the BLDC motor itself may all be thermally monitored. A KTY83/121 or equivalent temperature sensor mounted in thermal contact with the respective device is all that is required. Correct polarity must be observed for KTY-type temperature sensors.

Currently external temperature sensing does not trigger any actions – it is merely for operator information.

4.5 Safe Operating Area

Although the 250W PMU is capable of generating 250W of output power across a wide range of input voltages, caution must be exercised when operating from low input voltages. The difficulty with low input voltages is that the 28V Buck-Boost converter in the PMU is maximally stressed and generates a significant amount of heat.

In order to achieve reliable operation, it is important to stay within the PMU's Safe Operating Area (SOA) shown in Graph 1 below:

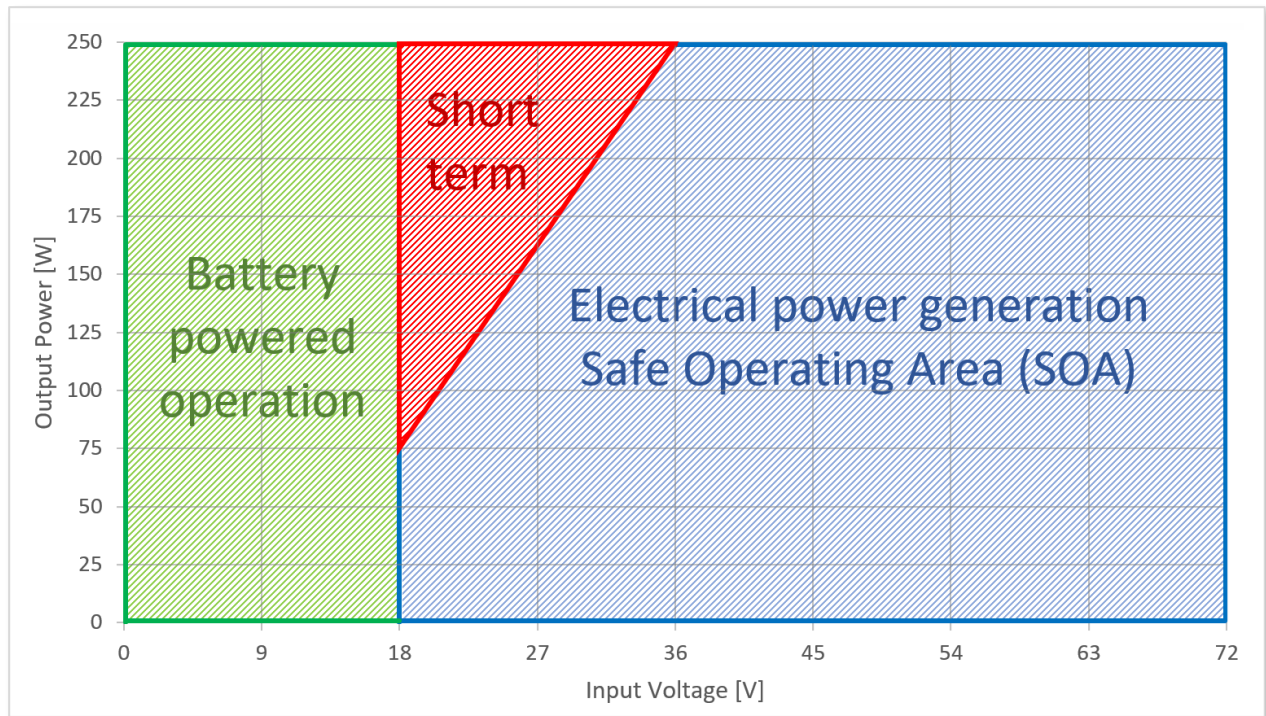

Graph 1 – Safe Operating Area (ambient temperature +25°C, fan fitted and running)

"Output Power" refers to the total output power, i.e. the sum of all powers drawn from Battery Chargers A and B, Avionics, Servo, Payload outputs and the 28V bus.

"Input Voltage" refers to the 3-phase input voltage (V_{PP} phase-to-phase), or the Umbilical input voltage (whichever is greater).

As can be seen from Graph 1, the critical area is from 18 to 36V input voltage. When the input voltage is in this range, the output power should be limited so that the PMU stays within its SOA (shown in blue). It is permissible to draw rated power (250W) when the input voltage is in this range, but only for short periods of time (10 seconds max. at 10% duty cycle max.).

Operating in the red "Short term" area for greater than 10 seconds or with a duty cycle greater than 10% risks catastrophic thermal failure.

Graph 1 shows the SOA for an ambient temperature of +25°C with a fan fitted and running. Operating at elevated ambient temperatures reduces the thermal margin. Derate the SOA (by shifting the red "Short term" area downwards) by 1W for every degree the ambient temperature exceeds +25°C. For example, at an ambient temperature of +40°C, the maximum continuous output power at 18V input voltage is $75 - (40 - 25) = 60W$.

Firmware version 1.16 offers a new feature that manages the SOA automatically. Operation outside the SOA is still permitted but is automatically limited to 10 seconds and 10% duty cycle. The PMU will revert to battery operation as required. Outputs are unaffected, except for the 28V bus which will assume the highest battery voltage present. It is recommended that this feature be enabled.

5 Communications

The 250W PMU has both RS232 and CANbus interfaces that perform essentially the same functions, these being:

- Configuration (of parameters stored in the PMU's non-volatile memory),
- Control (real-time control of the PMU's various features),
- Monitoring (of measured voltages, currents, temperatures, etc), and
- Updating the PMU's firmware (RS232 only).

Once the PMU has been configured, there is no requirement to connect anything to either communications interface – the PMU will operate quite normally with no communications at all.

5.1 RS232 interface

The RS232 interface operates at 57600 baud, full-duplex, with 8 data bits and no parity (57600 8N1). The RS232 hardware layer is compliant with TIA/EIA-232-F and ITU V.28.

A Windows application that provides easy access to most of the 250W PMU's various features may be downloaded from www.millswoodeng.com.au/downloads.html



Figure 3 – 250W PMU configuration utility

Using the configuration utility relieves the user from the burden of writing software in order to configure and control the PMU. The RS232 protocol is described in a separate document for the purpose of more tightly integrating the PMU with other hardware and software.

5.2 CAN interface

CAN offers faster and more reliable communication than is possible with RS232. The PMU's CAN interface operates at 1Mbit/s and is compatible with Cloud Cap Technology CAN devices.

The CAN bus is not terminated internally.

The CAN protocol is described in a separate document for the purpose of more tightly integrating the PDU with other hardware and software.

6 Connectors

Four connectors required to interface with the PMU, two of each type listed in Table 3 below. The connectors specified are from the Harwin M80 Datamate MixTek series. Connectors are available ex-stock from the major online distributors.

Connector	Harwin part number	Online distributors
X1, X3	M80-4C11205F1-04-325-00-000	Mouser (PN: 855-M804C11205F14325) Digi-Key (PN: 952-1264-ND)
X2, X4	M80-4C10405F1-04-325-00-000	Mouser (PN: 855-M804C10405F14325) Digi-Key (PN: 952-1258-ND)

Table 3 – Connector part numbers

6.1 X1 – BLDC motor

Connect the 3 terminals of a suitable brushless DC motor to pins A, B and C of X1 (see Appendix 1 – Choosing a suitable BLDC motor). Over the operating rpm range that electrical power generation is desired, the peak voltage must be in the range 18 to 72V. This corresponds to an operating rpm range of 4:1.

The voltage can be calculated using the following formula:

$$V_p = \text{rpm} / K_v$$

For example, a brushless DC motor with a K_v of 346 rpm/V rotating at 20,000 rpm will generate $20,000 / 346 = 57.8V$ peak. Note that this formula neglects losses and gives an upper bound on the peak voltage. Under load, the voltage will be somewhat less.

If the brushless DC motor has a star-connected winding and the neutral is externalised, **do not connect it to anything**. It must be securely insulated from all other connections.

Pin D of X1 is a low-impedance ground that may be connected to airframe ground if a chassis earth return system is implemented. Otherwise, connection of this pin is optional.

Connection of Hall sensors is optional, although the PMU requires Hall input 1 to be connected if monitoring of the BLDC motor's speed is required. Hall power and ground are provided for convenience.

Most of the remaining pins on X1 relate to engine starting and are described in the next section.

Pin	Name	Type	Description
X1:A	BLDC phase A	I/O	Connect to one of the 3 BLDC motor terminals.
X1:B	BLDC phase B	I/O	Connect to one of the 3 BLDC motor terminals.
X1:C	BLDC phase C	I/O	Connect to one of the 3 BLDC motor terminals.
X1:D	Airframe ground	Ground	Optional connection.
X1:1	Hall 1	Input	Connect to open-collector output of Hall sensor 1.
X1:2	Hall 2	Input	Connect to open-collector output of Hall sensor 2.
X1:3	Hall 3	Input	Connect to open-collector output of Hall sensor 3.
X1:4	Direction	Input	Not used. Use Currawong Engineering's cEQUIP app to change the direction of rotation of the engine starter.
X1:5	Hall power	Output	+5VDC power output for Hall sensors.
X1:6	Hall ground	Ground	Ground connection for Hall sensors.
X1:7	Arm	Input	Hardware interlock to arm/disarm engine starting. Shorting to pin X1:8 enables engine starting. For safety reasons this is a purely hardware interlock that cannot be overridden.
X1:8	Arm ground	Ground	Ground connection for arm input.
X1:9	BLDC motor temperature sensor	Input	Connect to the anode (positive terminal) of a KTY83 temperature sensor that is in intimate thermal contact with the BLDC motor. Motor temperature sensing is optional.
X1:10	Sensor ground	Ground	Ground reference for motor temperature sensor.
X1:11	Start	Input	Shorting to pin X1:12 starts the engine.
X1:12	Start ground	Ground	Ground connection for start input.

Table 4 – X1 pin descriptions

6.1.1 Engine starting

A fully-integrated (internal) engine starter is available for units sourced from Currawong Engineering and their distributors. This plug-in module is manufactured and fitted by Currawong Engineering and is designed to complement their range of UAV engines and accessories.

Use of the engine starter requires the use of a BLDC motor fitted with Hall sensors, and these must all be connected to the PMU. Starting can be initiated either by switching the start pin to ground or by sending the PMU a command. In either case, the Arm pin must be taken and held low prior to attempting to start the engine. For safety reasons hard-wiring the Arm pin to ground is not permitted – a transition from high to low is required.

If engine starting is required, we strongly recommend contacting Currawong Engineering (www.currawongeng.com) or one of their distributors for an integrated solution. The engine, BLDC motor, PMU, ECU and fuel pump can be tightly mechanically and electrically integrated resulting in a more compact and reliable propulsion and power solution.

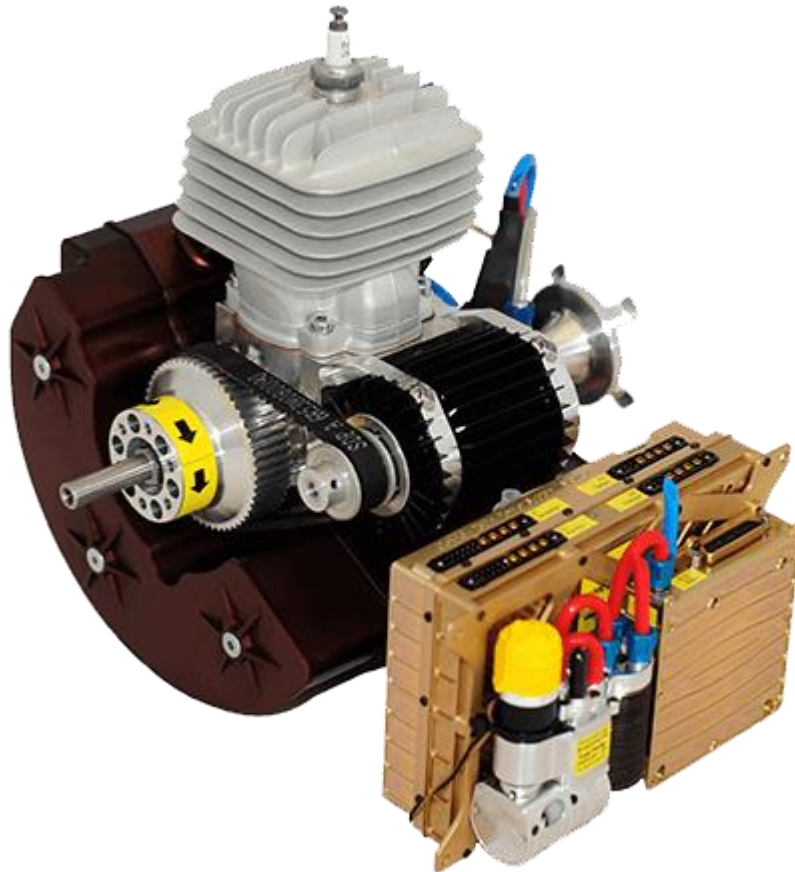

Figure 4 –Corvid 29 engine package from Currawong Engineering

Note that the Currawong Engineering variant of the 250W PMU is slightly different to the Millswood Engineering offering. The Currawong Engineering variant has a single (Avionics) LED on its front panel, and is a different colour. (The device shown in Figure 4 is gold; current production is silver). Other electrical and mechanical specifications are identical.

6.2 X2 – Batteries

The PMU supports the connection of up to two batteries, and these are managed completely independently. Internal low-loss battery switching is implemented such that disconnection or failure of either battery – even to a dead short – has no effect on operation of the PMU as long as an alternative source of power to the PMU is present (which may be battery, electrical power generation or umbilical power). It is possible – although perhaps not all that sensible – to operate the PMU with no batteries at all.

The PMU is operational whenever a battery is connected. It is therefore recommended to have a switch in series with the positive battery lead (or leads) in order to be able to turn the PMU off.

If engine starting is anticipated then Battery A must be fitted, as cranking current is drawn solely from Battery A. Battery B is highly recommended if in-flight engine re-starts are anticipated to prevent loss of electrical power if Battery A becomes depleted from repeated cranking.

Pin	Name	Type	Description
X2:A	Battery A +	I/O	Connect to positive terminal of Battery A.
X2:B	Battery A –	Ground	Connect to negative terminal of Battery A.
X2:C	Battery B +	I/O	Connect to positive terminal of Battery B. A second battery is optional.
X2:D	Battery B –	Ground	Connect to negative terminal of Battery B.
X2:1	Battery A temperature sensor	Input	Connect to the anode (positive terminal) of a KTY83 temperature sensor that is in intimate thermal contact with Battery A. Battery A temperature sensing is optional.
X2:2	Sensor ground	Ground	Ground reference for Battery A temperature sensor.
X2:3	Battery B temperature sensor	Input	Connect to the anode (positive terminal) of a KTY83 temperature sensor that is in intimate thermal contact with Battery B. Battery B temperature sensing is optional.
X2:4	Sensor ground	Ground	Ground reference for Battery B temperature sensor.

Table 5 – X2 pin descriptions

6.2.1 Choosing batteries

The following battery types are supported:

Battery type	Fully-charged terminal voltage
LiPo: 5S, 6S	21.0V, 25.2V
LiS: 8S, 9S, 10S	20.0V, 22.5V, 25.0V
LiFe: 6S, 7S	21.6V, 25.2V

Table 6 – Supported battery types

If two batteries are fitted they must have the same terminal voltage, although they may have different mAH capacities.

The PMU does not balance battery cell voltages. If the batteries do not have internal cell balancing circuitry they should be periodically removed from the aircraft for rebalancing.

6.2.2 Additional considerations when choosing battery voltage

When operating from battery power, output voltages will always be less than the applied battery voltage, some quite significantly so. Each switching power supply has its own particular voltage headroom requirements (see Graph 3 and Graph 4) that limit the maximum possible output voltages.

As a rough guide, if the highest output voltage is greater than 15V, then 6S LiPo (or equivalent) should be used. If the highest output voltage is less than 15V, then 5S or 6S LiPo (or equivalent) may be used. Using higher battery voltages is generally preferable as it gives greater headroom for the various switching converters and therefore longer running times when electrical power generation is not occurring.

Maintaining high output voltages from battery power alone is problematic. Even with 6S LiPos, under sustained load the battery voltage will eventually fall to the point where outputs come out of regulation due to having insufficient voltage headroom. Connecting peripheral devices directly across batteries is possible but not recommended, as the battery energy measurements will be invalid, and if the current drawn averages more than 1.2Amps the battery will never be charged.

Connecting peripheral devices that require a high voltage to the 28VDC bus is a better solution, as the 28VDC bus tracks the battery voltage very closely when electrical power generation is not occurring. The battery energy measurements will also be maintained correctly with this arrangement. Obviously this requires that the peripheral devices can tolerate 28V.

6.2.3 Battery chargers

The battery chargers are constant-current constant-voltage types. When the measured battery voltage is less than the configured battery voltage V_B , the chargers apply a constant charging current of approximately 1.2Amps. Once the battery voltage reaches V_B , the battery chargers transition to constant-voltage mode and the charging current reduces accordingly. This maintains full charge on the batteries without the risk of overcharging.

6.2.4 Low battery voltage cut-out

Low battery voltage cut-outs are implemented for the avionics, servo and payload outputs. Cut-outs only occur if battery power is the sole source of power available to the PMU. Cut-out thresholds are calculated from the configuration value for battery voltage V_B , so it is important that this value is set correctly.

The payload output shuts down when the measured battery voltage falls below 76% of the configuration value for battery voltage. This corresponds to a LiPo cell voltage of 3.2V/cell.

The avionics and servo outputs shut down when the battery voltage falls below 64% of the configuration value for battery voltage. This corresponds to a LiPo cell voltage of 2.7V/cell.

If two batteries are fitted, both batteries must fall below a given threshold in order to provoke the corresponding cut-out.

Note that low battery voltage cut-out is different to payload shedding, which – if enabled – occurs in response to loss of electrical power generation.

6.2.5 Minimum battery voltage requirement

When powering-up from battery power alone, there is a minimum voltage requirement which must be met before the PMU will turn its outputs on. This is to prevent an aircraft being inadvertently flown with discharged batteries. As for the low battery voltage cut-out, the threshold value is calculated from the configured value for battery voltage V_B .

The minimum voltage required when powering-up from batteries is 88% of the configuration value for battery voltage. This corresponds to a LiPo cell voltage of 3.7V/cell.

If two batteries are fitted, only one battery needs to meet the minimum battery voltage requirement.

Example

The battery is chosen to be a 6S LiPo. The battery voltage V_B is therefore configured to be 25.2V (4.2V/cell).

When powered-up from battery, the PMU's outputs will come on if the battery voltage exceeds 22.2V (88% of 25.2V).

When operating from battery power:

- If the battery voltage falls to 19.2V (76% of 25.2V), the PMU will shut-down the payload output.
- If the battery voltage falls to 16.2V (64% of 25.2V), the PMU will shut-down the avionics and servo outputs.

6.3 X3 – Avionics

The Avionics connector provides access to a range of different functions, these being:

- 28VDC (bi-directional bus)
- Umbilical power (input)
- Avionics power (output)
- Communications (RS232 and CAN)

The 28VDC bus provides 28VDC when electrical power generation is occurring. When electrical power generation is not occurring (i.e. the PMU is operating from battery power), the 28VDC bus is maintained at the highest available battery voltage. The 28VDC bus is bi-directional: if another source of 28VDC is present in the aircraft (such as from a second PMU in twin-engine aircraft), it may be connected directly to the 28VDC bus. This provides a level of power system redundancy.

The Umbilical power input is intended for powering the PMU externally when the aircraft is on the ground and electrical power generation is not occurring. The recommended voltage for the Umbilical input is 24 to 48VDC, although the PMU will operate more efficiently (and run cooler) if the applied voltage is between 38 and 48VDC.

Avionics power is provided on 3 pairs of pins to simplify harness wiring. It is intended to power mission-critical flight systems such as autopilot, ECU (Engine Control Unit), etc. The Avionics output voltage is user-programmable to any voltage from 12 to 21VDC. A hardware shutdown input is provided; if this pin is pulled low the Avionics output is turned off. Hardware shutdown overrides software control.

The communication interface protocols are described in separate documents.

Pin	Name	Type	Description
X3:A	28VDC bus	I/O	Industry-standard 28VDC bus.
X3:B	28VDC ground	Ground	Ground connection for 28VDC bus.
X3:C	Umbilical power	Input	Connect to an external source of DC power.
X3:D	Umbilical ground	Ground	Ground connection for umbilical power input.
X3:1	CAN H	I/O	
X3:2	Avionics shutdown	Input	Shorting to ground turns avionics power off. Leave open-circuit if functionality not required.
X3:3	RS232 Rx	Input	
X3:4	Avionics power	Output	Programmable-voltage uninterruptible power output. Intended for low-power mission-critical aircraft systems, such as autopilot, ECU, etc.
X3:5	Avionics power	Output	Duplicate of X3:4.
X3:6	Avionics power	Output	Duplicate of X3:4.
X3:7	CAN L	I/O	
X3:8	Comms ground	Ground	Ground reference for CAN and RS232.
X3:9	RS232 Tx	Output	
X3:10	Avionics ground	Ground	Ground connection for avionics power output
X3:11	Avionics ground	Ground	Duplicate of X3:10.
X3:12	Avionics ground	Ground	Duplicate of X3:10.

Table 7 – X3 pin descriptions

6.4 X4 – Servo / Payload

The Servo output voltage is user-programmable to any voltage from 5 to 12VDC, and the Payload output voltage is user-programmable to any voltage from 12 to 21VDC. Individual dedicated hardware shutdown inputs are provided; if either of these pins are pulled low the associated output is turned off. Hardware shutdown overrides software control.

Pin	Name	Type	Description
X4:A	Servo power	Output	Programmable-voltage uninterruptible power output. Intended for driving servos via a servo bus. Can be turned off via remote command or hardware signal.
X4:B	Servo ground	Ground	Ground connection for servo power output.
X4:C	Payload power	Output	Programmable-voltage uninterruptible power output. Intended for driving payload devices via a payload bus. Can be turned off via remote command or hardware signal.
X4:D	Payload ground	Ground	Ground connection for payload power output.
X4:1	Servo shutdown	Input	Shorting to ground turns servo power off. Leave open-circuit if functionality not required.
X4:2	Payload shutdown	Input	Shorting to ground turns payload power off. Leave open-circuit if functionality not required.
X4:3	Shutdown ground	Ground	Ground reference for servo shutdown input.
X4:4	Shutdown ground	Ground	Ground reference for payload shutdown input.

Table 8 – X4 pin descriptions

7 Front Panel Arrangement

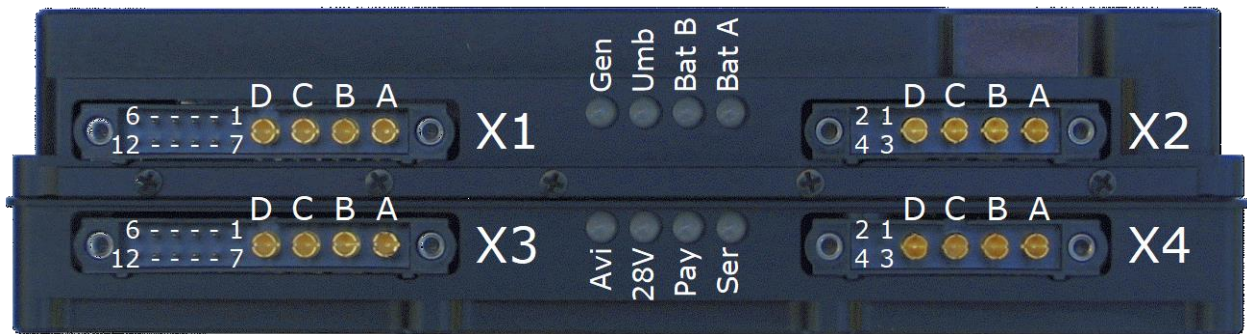

Figure 5 – Locations of connectors and visual indicators on the front panel

7.1 Connector pin locations

X1	BLDC MOTOR	X2	BATTERIES	X3	AVIONICS	X4	SERVO / PAYLOAD
A	BLDC phase A	A	Battery A +	A	28VDC power	A	Servo power
B	BLDC phase B	B	Battery A -	B	28VDC ground	B	Servo ground
C	BLDC phase C	C	Battery B +	C	Umbilical power	C	Payload power
D	Airframe ground	D	Battery B -	D	Umbilical ground	D	Payload ground
1	Hall 1	1	Bat A temp sensor	1	CAN H	1	Servo shutdown
2	Hall 2	2	Sensor ground	2	Avionics shutdown	2	Payload shutdown
3	Hall 3	3	Bat B temp sensor	3	RS232 Rx	3	Shutdown ground
4	Direction (not used)	4	Sensor ground	4	Avionics power	4	Shutdown ground
5	Hall power			5	Avionics power		
6	Hall ground			6	Avionics power		
7	Arm			7	CAN L		
8	Arm ground			8	Comms ground		
9	BLDC temp sensor			9	RS232 Tx		
10	Sensor ground			10	Avionics ground		
11	Start			11	Avionics ground		
12	Start ground			12	Avionics ground		

7.2 Visual indicator locations

NAME	FUNCTION	GREEN	RED	DARK
Gen	Generator status indicator	Generating	Starting	Neither
Umb	Umbilical power indicator	Present	-	Absent
Bat B	Battery B indicator	Charging	Discharging	Battery absent
Bat A	Battery A indicator	Charging	Discharging	Battery absent
Avi	Avionics power indicator	On	Overcurrent	Off
28V	28VDC power indicator	On	Overcurrent	Off
Pay	Payload power indicator	On	Overcurrent	Off
Ser	Servo power indicator	On	Overcurrent	Off

8 Specifications

8.1 Absolute Maximum Ratings *Note 1*

Symbol	Parameter	Min	Max	Unit
V _{BLDC}	BLDC motor voltage, phase-to-phase <i>Note 2</i>	-77.8	+77.8	V _{PP}
V _{UMB}	Umbilical input voltage	-50	+50	V _{DC}
V _{BAT}	Battery voltage <i>Note 2</i>	-30	+33.3	V _{DC}
V _{28VDC}	28VDC bus voltage <i>Note 3</i>	-1	+33.3	V _{DC}
V _{AVI}	Avionics output voltage <i>Note 3</i>	-1	+26.7	V _{DC}
V _{PAY}	Payload output voltage <i>Note 3</i>	-1	+26.7	V _{DC}
V _{SERVO}	Servo output voltage <i>Note 3</i>	-1	+13.3	V _{DC}
V _{RS232_I}	RS232 input voltage	-25	+25	V _{DC}
V _{RS232_O}	RS232 output voltage	-13.2	+13.2	V _{DC}
V _{CAN_L} , V _{CAN_H}	CAN L and H voltage	-42	+42	V _{DC}
V _{DIG}	Digital inputs (Start, Hall sensors)	-10	+15	V _{DC}
T _{INT}	Internal temperature	-55	+105	°C

Table 9 – Absolute Maximum Ratings

Note 1: Absolute maximum ratings are those values beyond which damage to the product may occur. Functional operation under these conditions is not implied (or recommended).

Note 2: Pin protected from overvoltage by a Transient Voltage Suppressor (TVS) diode. Excursions above absolute maximum rating will be clamped, resulting in large current flows.

Note 3: Pin protected from reverse and overvoltage by a TVS diode. Excursions below absolute minimum or above absolute maximum ratings will be clamped, resulting in large current flows.

8.2 Recommended Operating Conditions

Symbol	Parameter	Min	Max	Unit
V _{BLDC}	BLDC motor voltage, phase-to-phase	18	72	V _{PP}
V _{UMB}	Umbilical input voltage	24	48	V _{DC}
V _{BAT}	Battery voltage (fully charged, no load)	20.0	25.2	V _{DC}
V _{28VDC}	28VDC bus voltage	26.6	29.4	V _{DC}
T _{INT}	Internal temperature	-40	+85	°C
Alt	Altitude	0	10,000	m _{AMSL}

Table 10 – Recommended Operating Conditions

8.3 Thermal Characteristics

	Min	Typ	Max	Unit
Thermal resistance (battery power)				
Internal to ambient, no fan		3		°C/W
Internal to ambient, with fan		TBD		°C/W
Thermal resistance (umbilical power)				
Internal to ambient, no fan		TBD		°C/W
Internal to ambient, with fan		TBD		°C/W
Thermal resistance (electrical power generation)				
Internal to ambient, no fan		TBD		°C/W
Internal to ambient, with fan		TBD		°C/W

Table 11 – Thermal Characteristics

8.4 Electrical Specifications (-40 to +85°C, typical values given for +25°C)

8.4.1 Power outputs

	Min	Typ	Max	Unit
Battery chargers				
Output voltage range	20.0		25.2	V _{DC}
Output voltage accuracy		±0.1	±0.2	V _{DC}
Charging current (per battery)		1.2	1.5	A _{DC}
Avionics and Payload outputs				
Output voltage range	12.0		21.0	V _{DC}
Output voltage accuracy		±0.1	±0.2	V _{DC}
Continuous output current capability ^{Note 1}	7.5			A _{DC}
Peak output current capability ^{Note 2}	9			A _{DC}
Continuous output power			120	W
Line regulation		Unmeasurable	^{Note 3}	mV
Load regulation			TBD	mV
Output noise			TBD	mV
Servo output				
Output voltage range	5.0		12.0	V _{DC}
Output voltage accuracy		±0.1	±0.2	V _{DC}
Continuous output current capability	10			A _{DC}
Peak output current capability ^{Note 2}	12			A _{DC}
Line regulation		Unmeasurable	^{Note 3}	mV
Load regulation			TBD	mV
Output noise			TBD	mV
28VDC bus				
Output voltage	27.3	28.0	28.7	V _{DC}
Continuous output current			9	A _{DC}
Hall sensor power output				
Output voltage	4.8	5	5.2	V _{DC}
Continuous output current			50mA	A _{DC}
All outputs				
Total continuous output power ^{Note 4}			250	W

Table 12 – Power outputs

Note 1: Derate current linearly above 16VDC to observe continuous output power specification.

Note 2: Maximum of 10 seconds per minute.

Note 3: Less than output noise.

Note 4: $V_{BLDC} > 36V_{PP}$ OR $V_{UMB} > 36V_{DC}$. If both V_{BLDC} and V_{UMB} are less than 36V, derate total continuous output power to remain within safe operating area as described in section 4.5.

Current capability specifications give the minimum current that an output is guaranteed to be able to deliver.

8.4.2 Quiescent characteristics

	Min	Typ	Max	Unit
Quiescent battery current (0V < V_{BAT} < 26V)				
All outputs off		52	90	mA
Payload output on (V _P =12V)		91	115	mA
Avionics & servo outputs on (V _A =12V, V _S =6V)		111	160	mA
All outputs on (V _P =12V, V _A =12V, V _S =6V)		147	185	mA
Quiescent battery power (0V < V_{BAT} < 26V)				
All outputs off		1.1	1.6	W
Payload output on (V _P =12V)		1.9	3.0	W
Avionics & servo outputs on (V _A =12V, V _S =6V)		2.3	3.4	W
All outputs on (V _P =12V, V _A =12V, V _S =6V)		3.1	4.7	W

Table 13 – Quiescent characteristics

Typical values given for V_B = 21V. See Graph 2 for detailed characterisation.

8.4.3 Communications interfaces

	Min	Typ	Max	Unit
CAN				
Baud rate		1.0000		Mb/S
Baud rate stability	-50		+50	ppm
RS232				
Baud rate		57.6		kb/S

Table 14 – Communications interfaces

8.4.4 Digital and analog inputs

	Min	Typ	Max	Unit
Shutdown inputs (Avionics, Servo and Payload)				
Resistance to ground to enable			1.0	kΩ
Resistance to ground to disable	200			kΩ
Arm input ^{Note 1}				
Required current capability of input switch		1.5	3	mA
Input current to disarm			15	μA
Digital inputs (Start, Hall sensors)				
High-level input voltage	3.0			V
Low-level input voltage			1.0	V
Input pull-up resistance (to +5.0V)		10		kΩ
Temperature sensor inputs (Batteries, Engine starter, BLDC motor)				
Bias current (KTY83/121, -55 to +125°C)	0.75	1.5	2.5	mA

Table 15 – Digital and analog inputs

Note 1: A transition from disarmed to armed is required to enable the engine starter.

8.4.5 Monitoring

	Min	Typ	Max	Unit
Voltage monitoring				
Accuracy (battery chargers, avionics, servo, payload)		±0.1	±0.2	V _{DC}
Accuracy (28VDC bus)		±0.2	±0.4	V _{DC}
Accuracy (Electrical power generation)		±0.4	±0.8	V _{DC}
Current monitoring				
Accuracy (battery chargers, avionics)		±0.1	±0.2	A _{DC}
Accuracy (28VDC bus)		±0.2	±0.4	A _{DC}
Accuracy (servo, payload)		±0.4	±0.8	A _{DC}
Temperature monitoring				
Accuracy (PMU) ^{Note 1}		±10		°C
Accuracy (batteries, engine starter, BLDC motor) ^{Note 2}		±1		°C
Speed monitoring				
Accuracy (BLDC motor)		±150		RPM

Table 16 – Monitoring

Note 1: Requires calibration parameter T_0 to be set correctly in order to achieve specified accuracy.

Note 2: Using external KTY83/121 sensor.

8.5 Typical Characteristics (+25°C)

8.5.1 Quiescent battery current

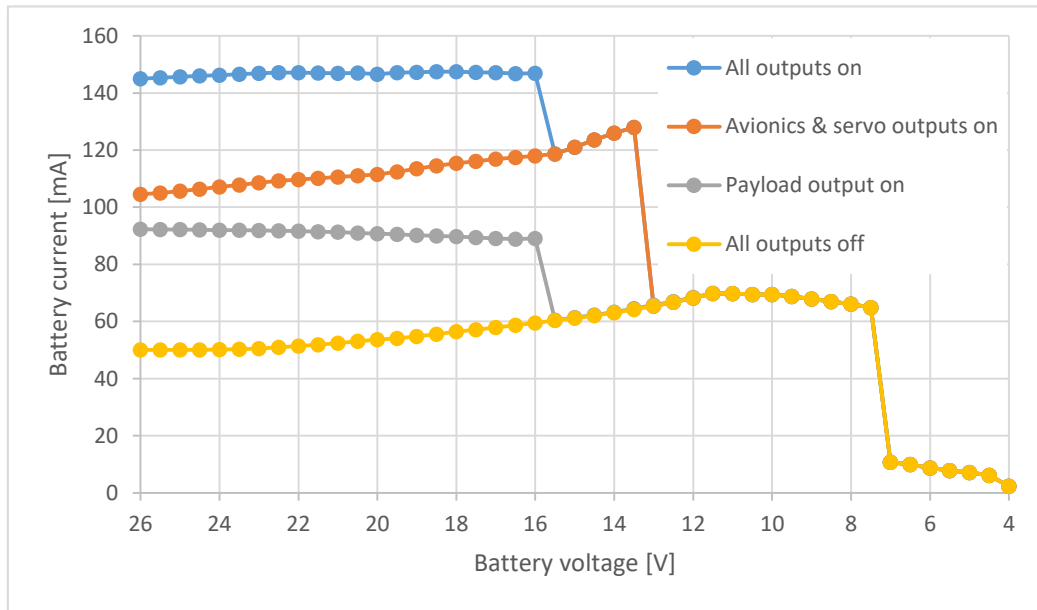

Graph 2 – Quiescent battery current

Test conditions: $V_A=12V$, $V_S=6V$, $V_P=12V$, $V_B=21V$ (configuration values). Battery voltage V_{BAT} swept from 26 to 4V.

Note low battery voltage cut-outs at 16.0V (payload output shuts down at 76% of V_B), and at 13.4V (avionics and servo outputs shutdown at 64% of V_B).

8.5.2 Avionics output dropout voltage

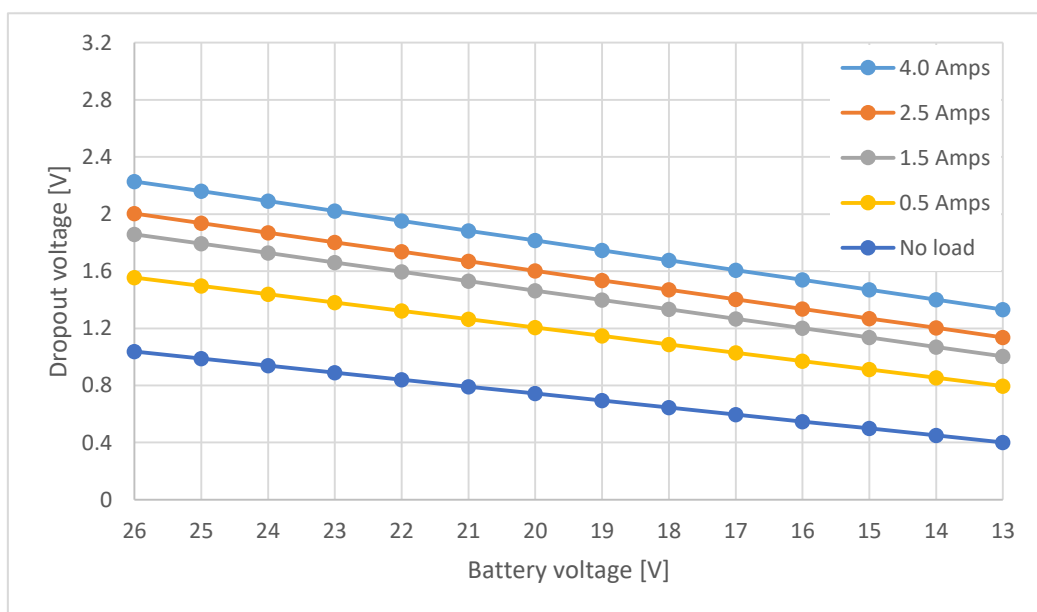

Graph 3 – Avionics output dropout voltage

Note that the dropout voltages shown in Graph 3 above only apply when operating from battery power. If electrical power generation or umbilical power are present then the full voltage ranges as given in Table 12 are available.

8.5.3 Maximum payload and servo output voltages

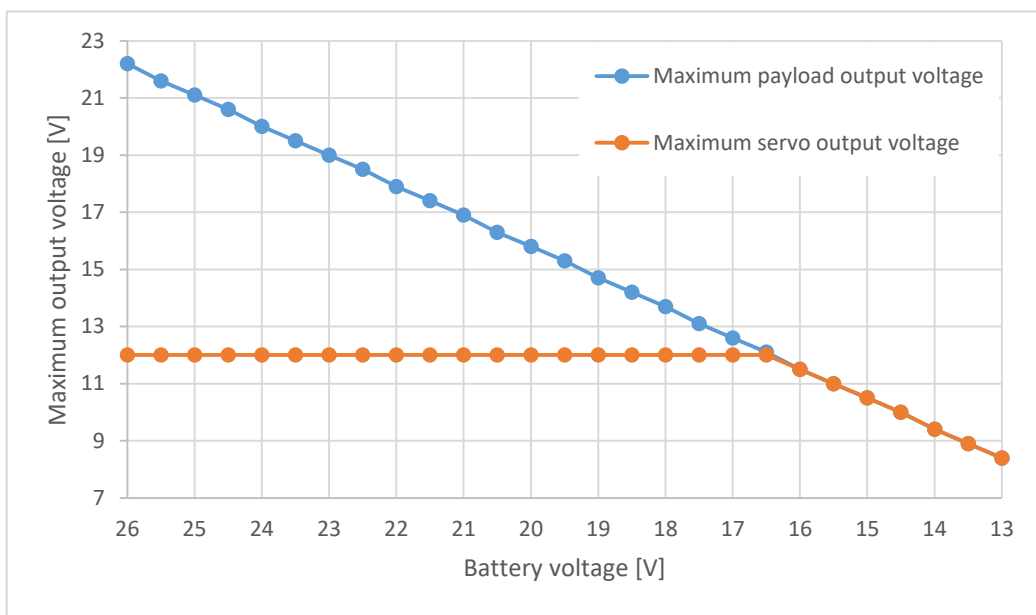

Graph 4 – Maximum payload and servo output voltages

Note that the maximum payload and servo voltages shown in Graph 4 above only apply when operating from battery power. If electrical power generation or umbilical power are present then the full voltage ranges as given in Table 12 are available.

For payload and servo outputs the maximum possible voltages are independent of output current.

8.6 Mechanical Characteristics

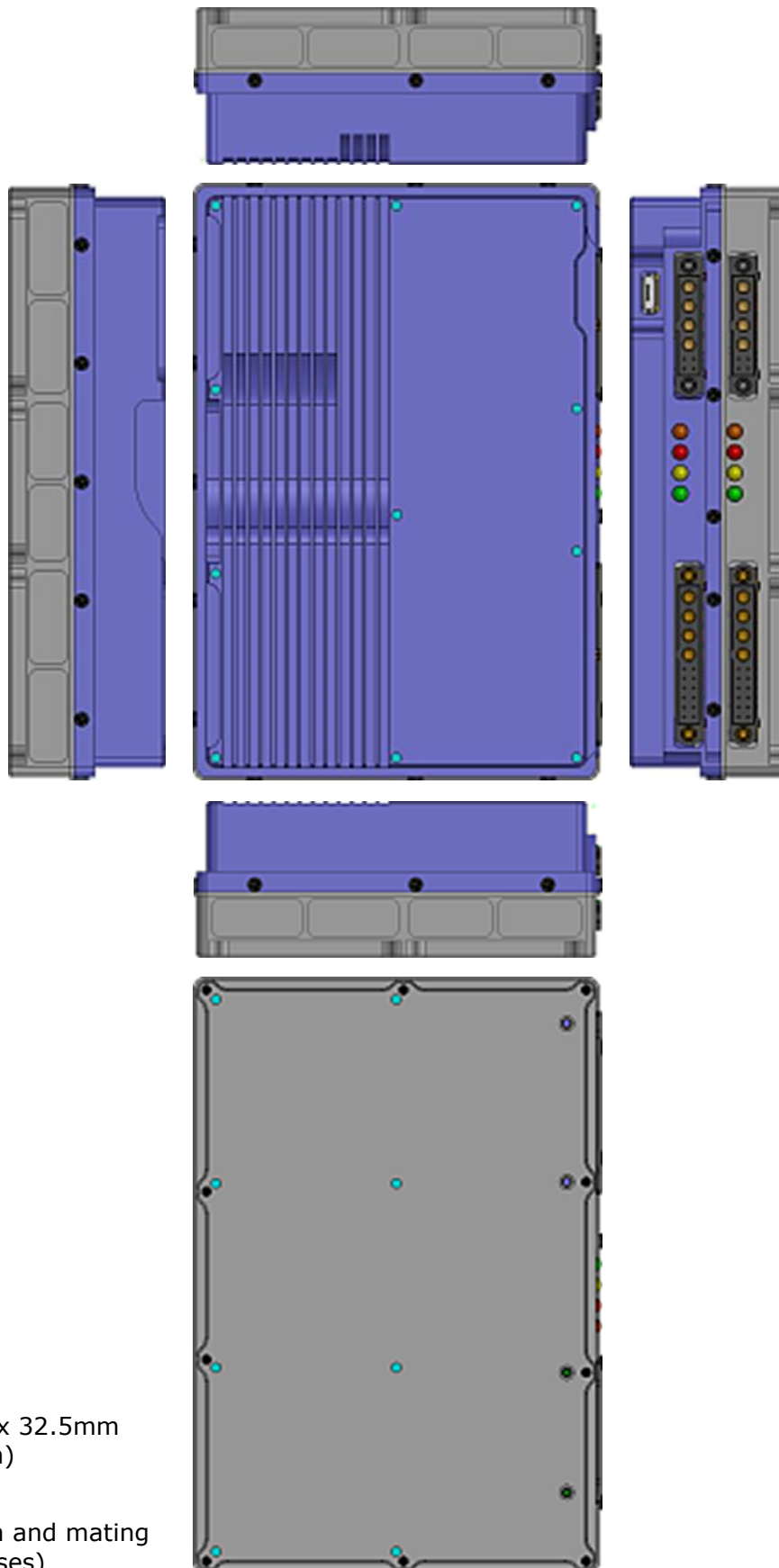

Dimensions:
124.4 x 85.0 x 32.5mm
(excluding fan)

Mass: 290g
(excluding fan and mating
wiring harnesses)

8.6.1 Mounting

The underside of the enclosure has 10 x M2 tapped holes for mounting the PMU to a flat surface. A template for drilling holes into the mounting surface is given in Figure 6 below:

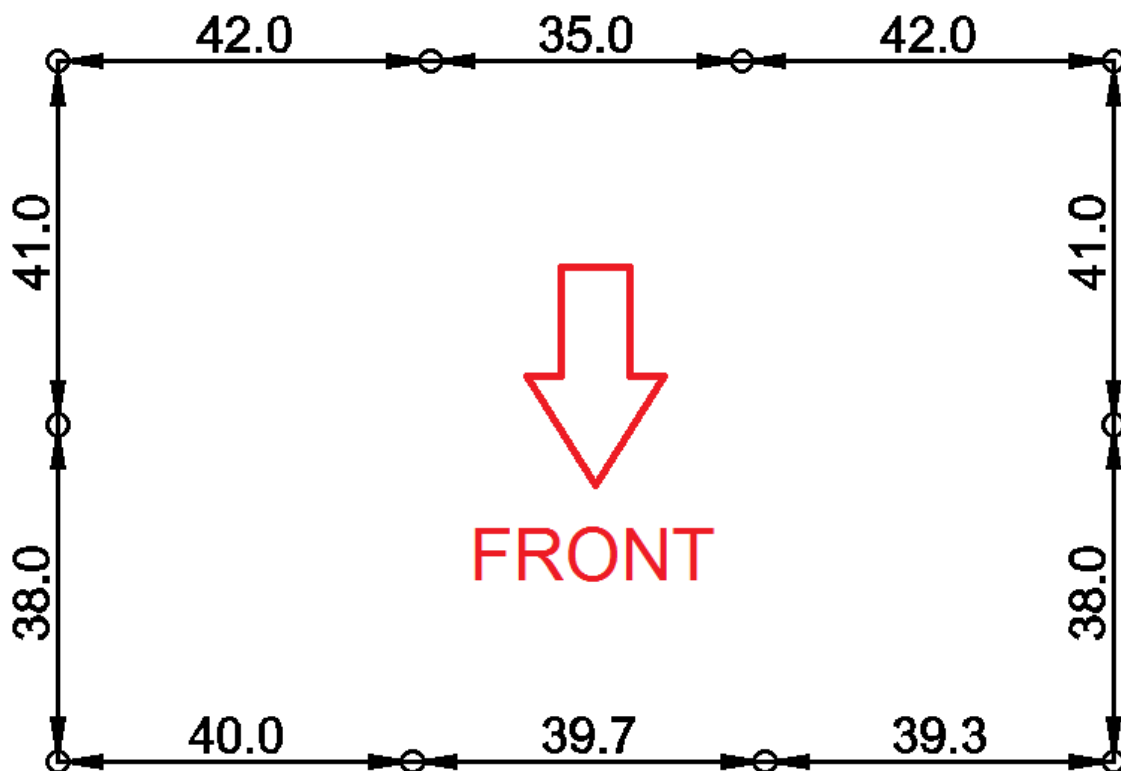

Figure 6 – Mounting hole locations

Be careful not to distort the enclosure by mounting to a warped surface. Mounting screws should project no more than 4.0mm into the enclosure.

9 Document version history

9.1 1.0 -> 1.1

9.1.1 Typical Performance Characteristics

- Added quiescent battery current graph.
- Added maximum payload and servo output voltage graph.

9.1.2 Interfacing renamed to Operation

- Divided content into sections covering global features.
- Clarified operation of hardware shutdown inputs (with respect to precedence over with software control of output state).
- Added section on temperature monitoring (internal and external) to reflect firmware version 1.12 which supports external temperature sensing.

9.1.3 Connectors section moved to precede sub sections describing each connector

- X1 – BLDC motor / description of engine starting added.
- X2 – Batteries / battery charger description updated to reflect changed battery charging current. All units from serial number 00032 onwards have battery charging current set to 1.2Amps maximum (reduced from 2.5Amps).
- X2 – Batteries / description of low battery voltage cut-out added.
- X2 – Batteries / description of minimum battery voltage requirement added.

- X4 – Payload shutdown pin listed incorrectly as X4:3. Corrected to be X4:2.

9.1.4 Front Panel Arrangement

- Payload shutdown pin listed incorrectly as X4:3. Corrected to be X4:2.

9.1.5 Specifications

- Battery charging current reduced from 2.5Amps to 1.2Amps. All units from serial number 00032 affected.
- Minimum battery voltage changed from 16.8V to 20.0V.

9.2 1.1 -> 1.2

9.2.1 Typical Performance Characteristics

- Document section numbering added.
- Added avionics output dropout voltage graph.
- Scales adjusted on maximum payload and servo output voltage graph to better reflect normal operating conditions.

9.3 1.2 -> 1.3

9.3.1 This section renamed to Document version history

9.3.2 Mechanical Characteristics

- 3rd angle projection drawing rotated to suit portrait page orientation.

9.3.3 Appendix 2 – Thermal Management

- Fan powering recommendation added.

9.3.4 Connectors

- Verical deleted as online supplier for connectors.

9.3.5 Document reformatted to suit printing and binding

9.4 1.3 -> 1.4

9.4.1 Safe Operating Area

- Section 4.5 “Safe Operating Area” added.
- Section 8.4.1 updated to mention safe operating area with regard to total continuous output power.

9.4.2 CAN interface

- Section 5.2 description updated to reflect revision 3 hardware which has no facility for internal CANbus termination.

9.5 1.4 -> 1.5

9.5.1 Direction input

- Table 4 pin X1:4 “Direction” input changed to not used.
- Section 7.1 updated to state that direction pin is not used.

9.5.2 Firmware version 1.16

- Section 4.5 updated to describe the “Manage safe operating area” feature available in firmware version 1.16.

10 Appendix 1 – Choosing a suitable BLDC motor

10.1 Types of BLDC motors

BLDC motors are available in two basic configurations, commonly known as “inrunners” and “outrunners”. Inrunners have the magnets attached to the central shaft, and this assembly rotates within the surrounding (fixed) windings. Outrunners have the opposite arrangement, with the magnets attached to the external housing which rotates around the inner (fixed) windings.

Outrunners with suitable Kv and power ratings for use in electric power generation are cheap and readily available. They have excellent power density per unit volume and per unit weight. However, outrunners tend to have an open style of construction and this makes them vulnerable to ingesting airborne contaminants.

Inrunners have a non-rotating outer case and can therefore be sealed against the ingress of airborne contaminants. This makes inrunners a better choice for most UAV applications.

10.2 Calculating the optimal Kv

In order to maximise power output, the PMU’s BLDC input should be operated as near to 72V as possible **but without ever exceeding this value**. In other words, 72V should correspond to the maximum RPM ever expected from the internal combustion engine.

The equation relating these parameters is:

$$\text{BLDC_voltage} = \text{RPM} \times \text{Gear_ratio} / \text{Kv}$$

Where Gear_ratio = BLDC motor speed / Internal combustion engine speed

Rearranging the first equation for Kv:

$$\text{Kv} = \text{RPM} \times \text{Gear_ratio} / \text{BLDC_voltage}$$

Example

A system has a maximum engine speed of 8500 RPM and a 53:19 (2.79) step-up belt drive to the BLDC motor. The equation for Kv is:

$$\text{Kv} = 8500 \times 2.79 / 72$$

$$\text{Kv} = 329 \text{ RPM/V}$$

The Kv calculated is a *minimum* value (i.e. using Kv values less than 329 RPM/V will generate *more* than 72V at 8500 RPM). A BLDC motor should be chosen with a Kv as close as possible to 329 RPM/V, but not less than this value.

The maximum permissible speed rating of the BLDC motor must also be observed. In the example above the maximum speed is $8500 \times 2.79 = 23,711$ RPM, and so the BLDC must be rated for operation to this speed.

10.3 Pole count

At least 4 poles (2 pole pairs) are recommended. There is no upper limit on the number of poles.

10.4 Recommended BLDC motors

Maxon EC (Externally Commutated) motors have been widely used in UAVs, and have proved to be reliable workhorses. A suitable motor for the example given above is Maxon 305015 – this device has a Kv of 346 RPM/V and a maximum permissible speed of 25,000 RPM.

11 Appendix 2 – Thermal management

All power conversion devices generate heat, and getting rid of this unwanted heat is one of the main factors limiting maximum continuous output power. Operation at elevated temperatures for extended periods of time also impacts negatively on reliability and service life. For these reasons it is worth taking some time to ensure that the PMU is operated at the lowest possible internal temperature.

Most devices quote a maximum ambient operating temperature, but this figure is of little practical value. A more useful measure of thermal performance is thermal resistance – this figure is given in degrees per Watt and allows calculation of the device temperature under different operating conditions. Note that the power used in thermal resistance calculations is the dissipated power, not the output power. To calculate the dissipated power the following formula is used:

$$P_{\text{DISSIPATED}} = P_{\text{OUTPUT}} \times (1 - \eta) / \eta \quad \text{where } \eta \text{ is the efficiency ranging from 0 to 1}$$

The dissipated power is then multiplied by the thermal resistance to give temperature rise above ambient. The PMU has a worst-case thermal resistance of X.X°C/W (mounted horizontally in still air). This can be improved to 0.XX°C/W with sufficient airflow.

11.1 Recommendations

The goal of thermal design should be to maintain the PMU's internal temperature below +85°C. Operation between +85 and +105°C is permitted but not recommended for extended periods of time. Internal temperature is reported in the telemetry data stream, and there is a user-programmable thermal cut-out that is set to +85°C by default.

If no fan is to be used and the PMU is installed in a stagnant environment, the PMU should be mounted such that the top and bottom panels are oriented vertically. This promotes the formation of natural convection currents.

If possible the PMU should be installed such that natural airflow is able to pass across as much surface area as possible. PMU orientation is less important when airflow is present. Many of the heat-generating components within the PMU are in thermal contact with the top panel, and this is where airflow will have the most benefit.

If high power is to be drawn from the PMU and natural airflow is limited, then a fan should be installed using the fan mounting bracket. PMU orientation is irrelevant if a fan is present. EBM-Papst 414F is a reasonable choice for 28VDC operation, although obviously other possibilities exist. The EBM-Papst 414F may be powered directly from the 28V bus.

As a rough guide, if more than 150W is to be drawn from the PMU continuously a fan is recommended.